

MaxiFil Clean - Art. No.: 67 150 104

- » Contamination free dust disposal
- » Automatic filter cleaning



Applications

- » Also suitable for high-alloy steel
- » High levels of smoke and dust
- » Non-stop operation

Benefits

- » Safe operation by rotation field control
- » Exhaust arm requires less adjustment due to flow-optimised exhaust hood design
- » Increased safety due to filter monitoring
- » Increased safety by means of automatic dust removal in cartridges, contamination-free
- » Very economic due to long lasting high capacity filters

Properties

- » Automatic filter cleaning
- » Exhaust arm up to 4 m
- » Automatic Start/Stop (optional)
- » Lighting in the hood (optional)
- » Cleanable filter
- » Automatic dust removal - contamination-free
- » Rotating exhaust hood
- » Spark separator

Accessories

- » Automatic start/stop
- » Workplace lighting incl. on/off switch at the hood

Technical Data

Art. No.	67 150 104
Filter	
Filter stages	2
Filter method	Cleanable filter
Filter cleaning method	Rotating nozzle
Filter surface	15 m ²
Type of filter	Filter cartridge
Filter material	ePTFE membrane
Filter efficiency	> 99.9 %
Dust classification	M
Additional filters	Cyclone pre-filter
Basic data	
Extraction capacity	1100 m ³ /h
Dimensions (w x d x h)	810 x 940 x 1350 mm
Weight	206 kg
Motor power	1.5 kW
Power supply	3 x 400 V / 50 Hz
Rated current	3.2 A
Control voltage	24 V, DC
Noise level	72 dB(A)
Additional information	
IFA-Certification	W3-Approved
Fan type	Radial fan
Compressed air supply	5 - 6 bar
Quantity of extraction arms	1
Exhaust arm type	rigid metal tube arm
Diameter extraction arm	150 mm
Length of exhaust arm	3 m



Suitable for alveole exchangeable dusts
separation > 99 % of particles < 0,4 µm



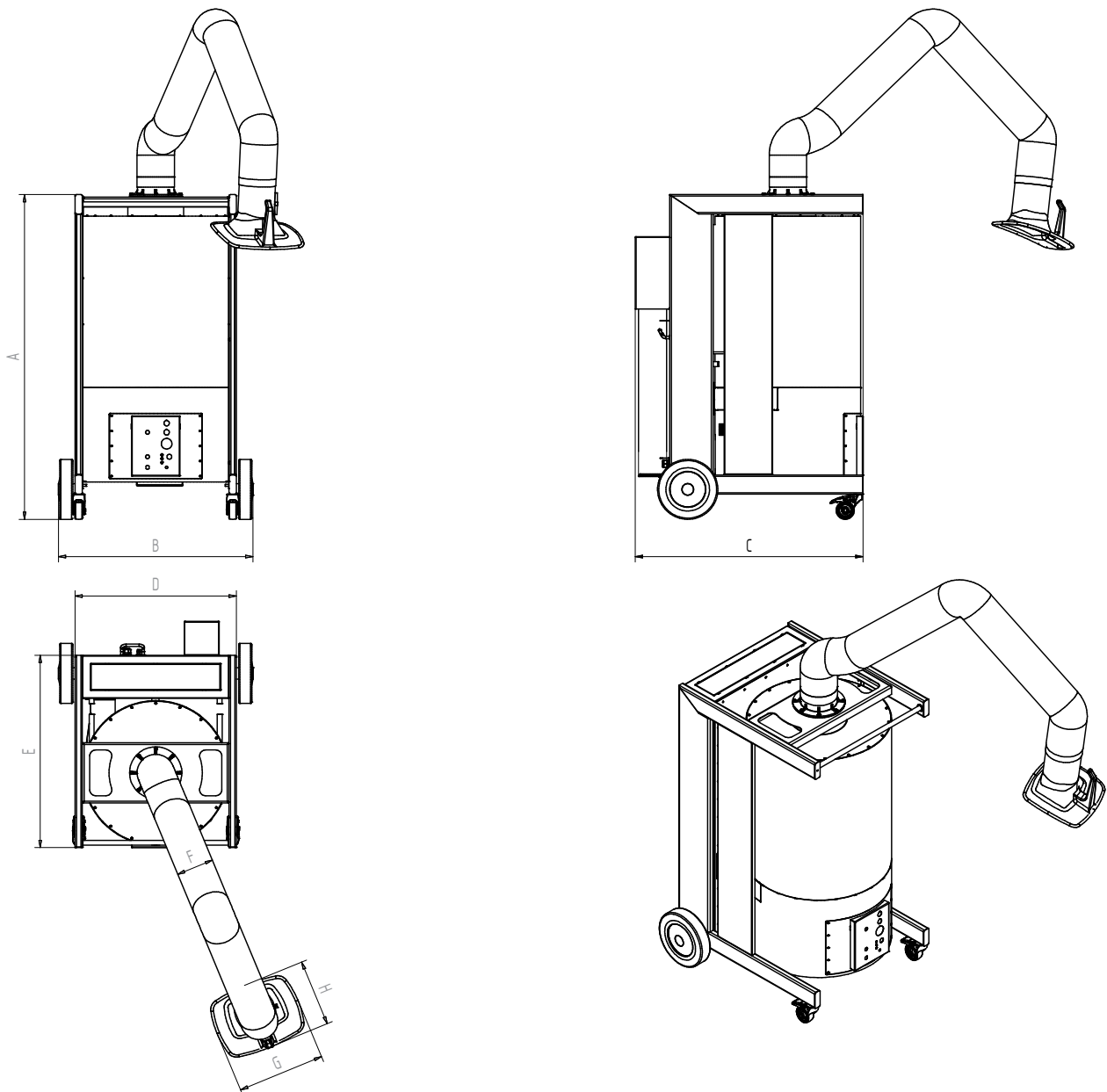

Technical Data

Dimensions

A	1350 mm
B	810 mm
C	940 mm
D	665 mm
E	798 mm
F	150 mm
G	360 mm
H	295 mm