

MaxiFil AC - Art. No.: 65 650 AK 102

- » Activated carbon filter
- » Safe filter change



Applications

- » Absorption of gases and odors
- » Medium levels of smoke and dust
- » Regular use

Benefits

- » Safe operation by rotation field control
- » Exhaust arm requires less adjustment due to flow-optimised exhaust hood design
- » Increased safety due to filter monitoring
- » Increased safety with safe filter change
- » Very economic due to long lasting high capacity filters

Properties

- » Exhaust arm up to 4 m
- » Automatic Start/Stop (optional)
- » Lighting in the hood (optional)
- » Activated carbon filter with 7.8 kg filling volume
- » Rotating exhaust hood

Accessories

- » Automatic start/stop
- » Workplace lighting incl. on/off switch at the hood

Technical Data

Art. No.	65 650 AK 102
Filter	
Filter stages	3
Filter method	Disposable filter
Filter surface	34 m ²
Type of filter	Safe Change Filter
Filter material	Non-woven polyester
Filter efficiency	> 99.5 %
Filter class	E12
Additional filters	Pre-filter (aluminum) and activated charcoal filter
Basic data	
Extraction capacity	950 m ³ /h
Weight	135 kg
Motor power	1.5 kW
Power supply	3 x 400 V / 50 Hz
Rated current	3.1 A
Control voltage	24 V, DC
Noise level	70 dB(A)
Additional information	
Fan type	Radial fan
Quantity of extraction arms	1
Exhaust arm type	flexible exhaust arm
Diameter extraction arm	150 mm
Length of exhaust arm	4 m

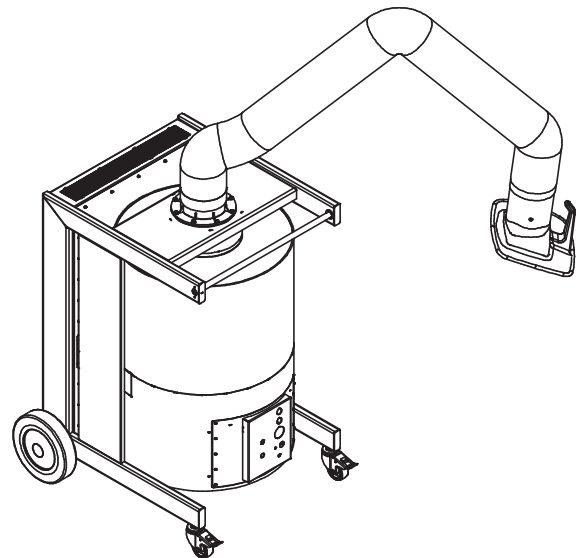
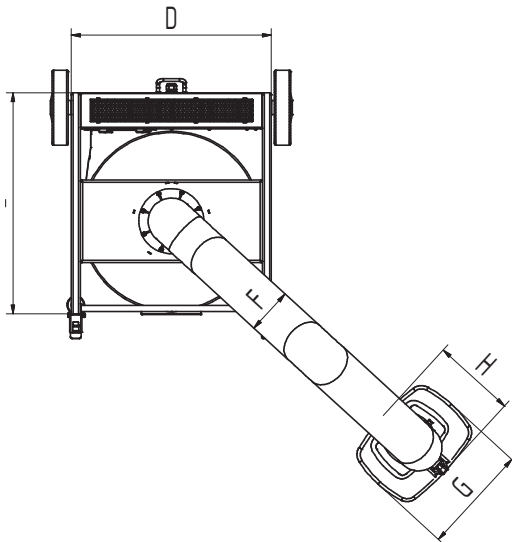
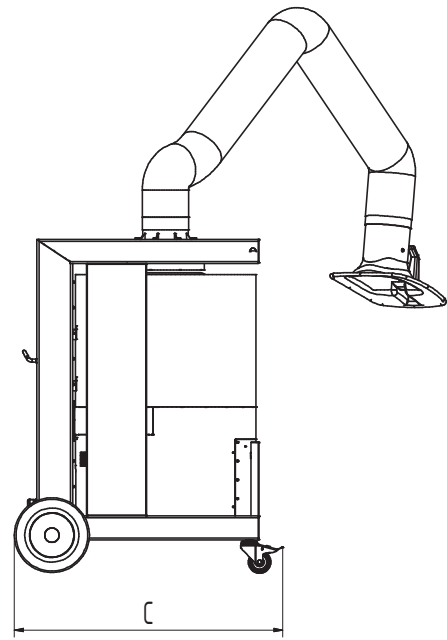
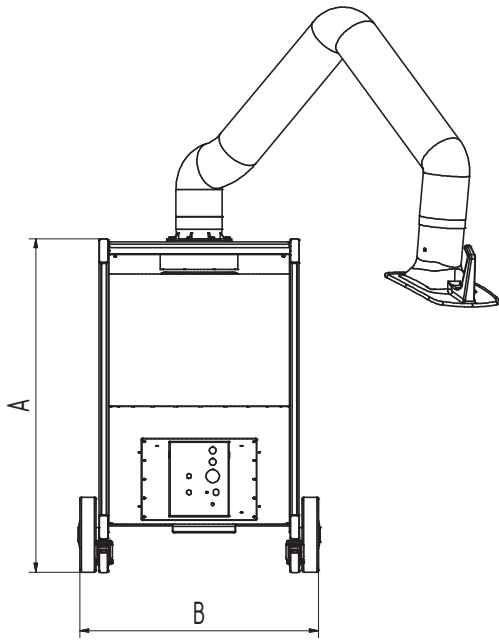

Technical Data

Dimensions	
A	1109 mm
B	803 mm
C	892 mm
D	665 mm
E	738 mm
F	150 mm
G	360 mm
H	295 mm