

SmartFil - Art. No.: 64 650 102

- » Professional extraction unit
- » Safe filter change



Applications

- » Medium levels of smoke and dust
- » Regular use
- » Alternating work places

Benefits

- » Exhaust arm requires less adjustment due to flow-optimised exhaust hood design
- » Increased safety due to filter monitoring
- » Increased safety with safe filter change
- » Very economic due to long lasting high capacity filters

Properties

- » 360 degrees rotating exhaust hood with damper
- » 25m² filter surface
- » Compact and solid design
- » Automatic Start/Stop (optional)
- » Lighting in the hood (optional)
- » Exhaust arm 4 m

Accessories

- » Automatic start/stop
- » Workplace lighting incl. on/off switch at the hood

Technical Data

Art. No.	64 650 102
Filter	
Filter stages	2
Filter method	Disposable filter
Filter surface	25 m ²
Type of filter	Safe Change Filter
Filter material	Non-woven polyester
Filter efficiency	> 99.5 %
Filter class	E12
Additional filters	Pre-filter (aluminium)
Basic data	
Extraction capacity	1100 m ³ /h
Weight	131 kg
Motor power	1.5 kW
Power supply	3 x 400 V / 50 Hz
Rated current	3.1 A
Control voltage	24 V, DC
Noise level	70 dB(A)
Additional information	
Fan type	Radial fan
Exhaust arm type	flexible exhaust arm
Length of exhaust arm	4 m



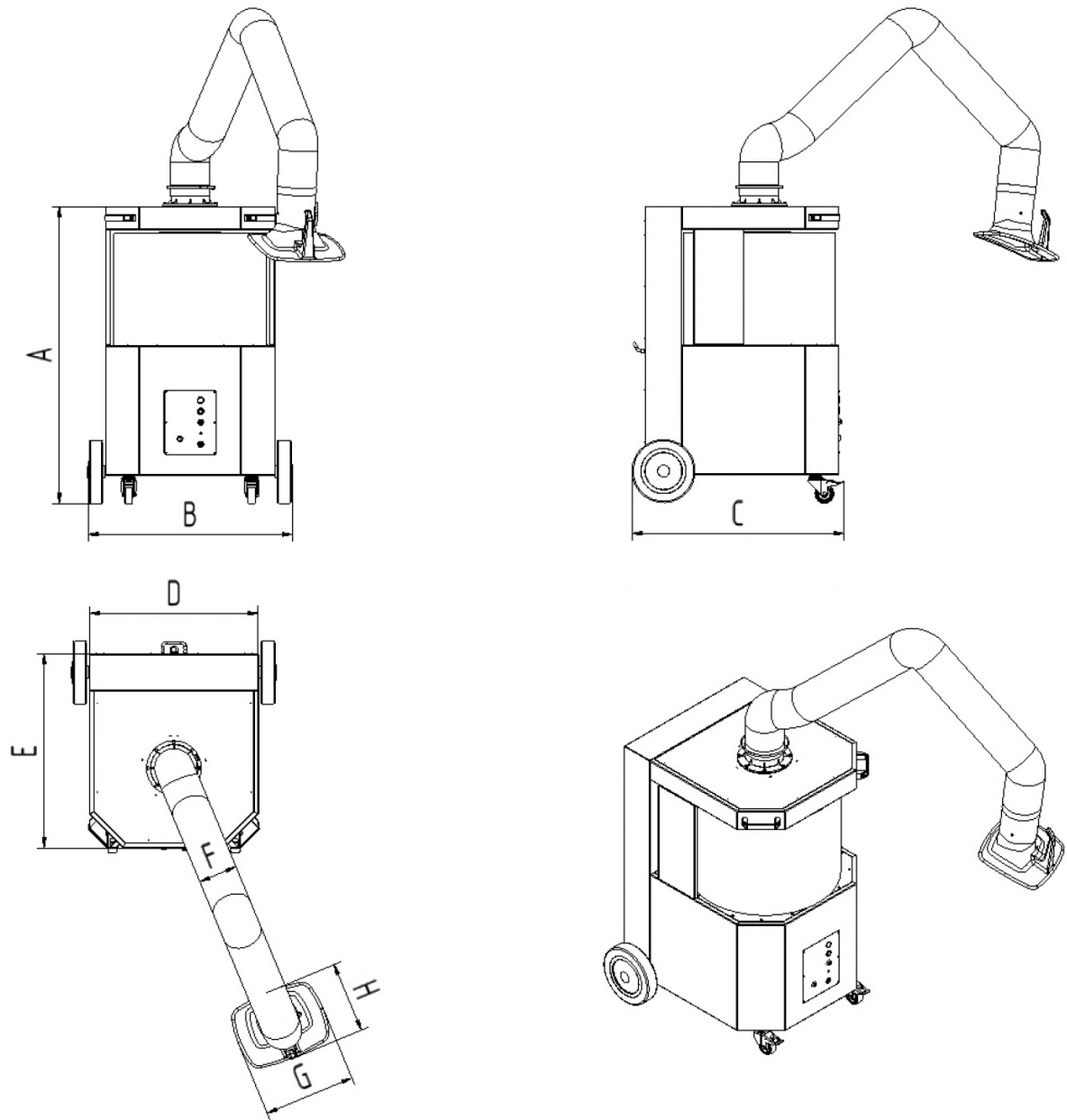

Technical Data

Dimensions	
A	1169 mm
B	795 mm
C	836 mm
D	667 mm
E	764 mm
F	150 mm
G	360 mm
H	295 mm