

SmartMaster - Art. No.: 64 330

- » Basic unit
- » Sporadic use



Applications

- » Also suitable for high-alloy steel
- » Low amounts of smoke/dust
- » Occasional use

Benefits

- » Exhaust arm requires less adjustment due to flow-optimised exhaust hood design
- » Increased safety due to filter monitoring
- » Flexible use due to hose connection

Properties

- » W3/IFA certified
- » Exhaust arm 3 m
- » Handle with cable holder
- » Rotating exhaust hood

Technical Data

Art. No.	64 330
Filter	
Filter stages	3
Filter method	Disposable filter
Filter surface	13 m ²
Type of filter	Filter cassette
Filter material	Non-woven fibre
Filter efficiency	> 99.5 %
Filter class	E12
Additional filters	Two pre-filters
Basic data	
Extraction capacity	950 m ³ /h
Weight	71 kg
Motor power	1.1 kW
Power supply	1 x 230 V / 50 Hz
Rated current	6.7 A
Control voltage	230 V, AC
Noise level	72 dB(A)
Additional information	
IFA-Certification	W3-Approved
Fan type	Radial fan
Quantity of extraction arms	1
Exhaust arm type	flexible exhaust arm
Diameter extraction arm	150 mm
Length of exhaust arm	3 m



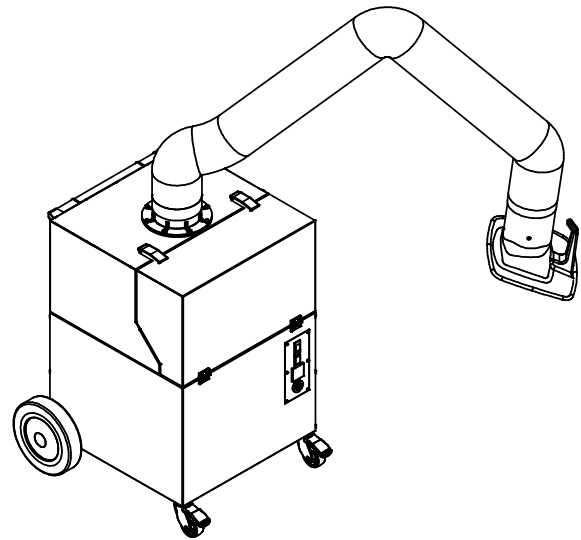
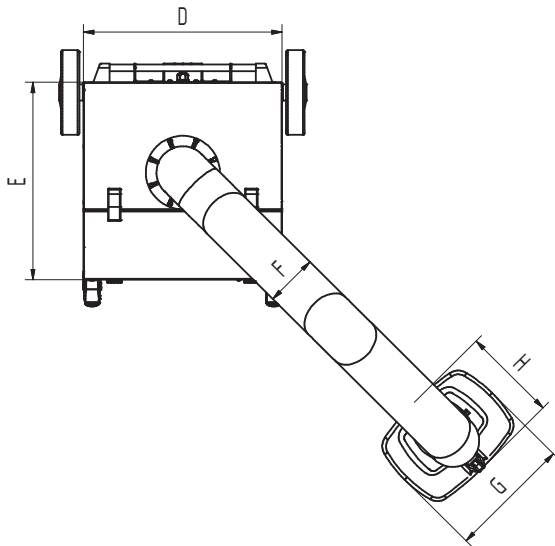
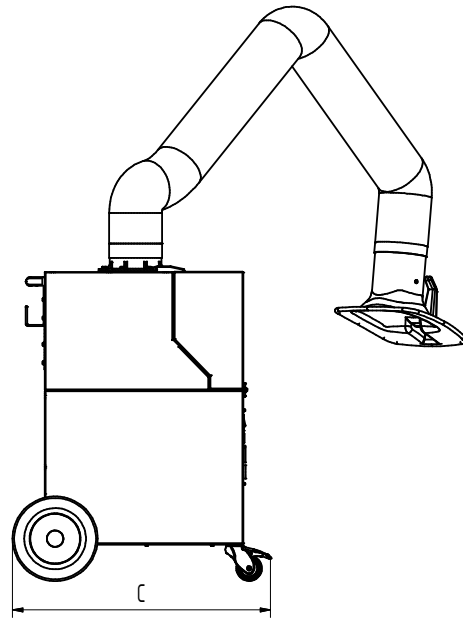
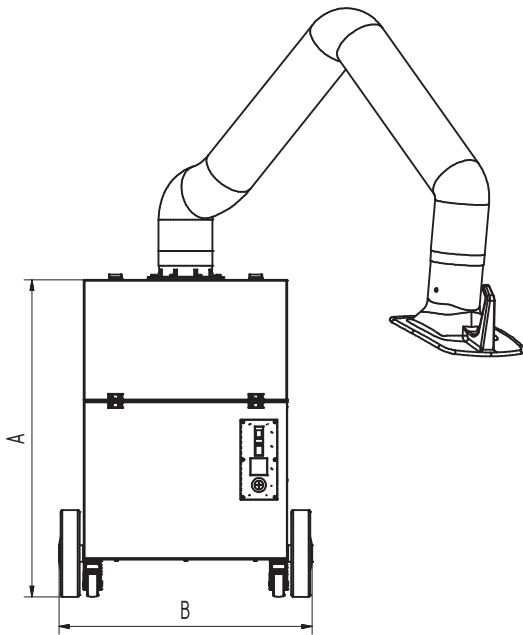

Technical Data

Dimensions	
A	909 mm
B	722 mm
C	753 mm
D	580 mm
E	580 mm
F	150 mm
G	360 mm
H	295 mm