

1/2" SOCKET WRENCHES



both in mm and inches

- 6 or 12 edges.



The sockets are made of **chrome-vanadium steel**, designed to withstand high tightening torques with minimal wear, providing the same greater durability.

SOCKET WRENCHES

1/2"
 mm



COD X	mm	L	A	B	C	MAXIMUM TORQUE Nm	gr.	1
61800	8mm	13				75	48	
61801	9mm	14			13	95	49	
61802	10mm	15				147	49	
61803	11mm	17				178		
61804	12mm	18		22		212	50	25
61805	13mm	19				249		
61806	14mm	20				288		
61807	15mm	22			14	331	55	
61808	16mm	22	38			377	60	
61809	17mm	24				425	65	20
61810	18mm					477	75	
61811	19mm	26	23			531		
61812	20mm						80	15
61813	21mm	28	24	15			110	
61814	22mm	30						
61815	23mm			26				
61816	24mm	40	32	26	16		115	10
61817	25mm							
61818	26mm	41	34	28	18	569	130	
61819	27mm	42	36	30				
61820	28mm						165	8
61821	29mm	44	38	30	20			
61822	30mm							
61823	32mm	45	42	38	22		210	7

UNE 16501:2009 (ISO 1711-1) Cr-V DIN 3124

- x 50% aerospace chrome plating
- x 50% mirror polished chrome plating
- y 100% mirror polished chrome plating

LIFETIME GUARANTEE*

SOCKET WRENCHES

1/2"

mm



COD X	mm	← L → ← A → ← B → ← C →				MAXIMUM TORQUE Nm	gr.		
61380	8mm					75	48		
61381	9mm					95	48		
61382	10mm					147	49		
61383	11mm					178			
61384	12mm					212			25
61385	13mm					249	50		
61386	14mm					288			
61387	15mm					331	55		
61388	16mm					377	60		
61389	17mm					425	65		20
61390	18mm					477	75		
61391	19mm					531			
61392	20mm						80		1
61393	21mm								15
61394	22mm						110		
61395	23mm								
61396	24mm	40					115		10
61397	25mm	41							
61398	26mm	41	34	28	18	569	130		
61399	27mm	42	36	30					
61400	28mm		38		20		165		8
61401	29mm	44			32		21		
61402	30mm		40		22				
61403	32mm	45	42	38	26		210		7

UNE 16501:2009 (ISO 1711-1) Cr-V DIN 3124

1/2"

Inch.



COD X	Inch.	← L → ← A → ← B → ← C →				MAXIMUM TORQUE Nm	gr.		
60460	5/16"					75	46		
60461	3/8"					147	49		
60462	7/16"					178	50		
60463	1/2"					249			25
60464	9/16"					288			
60465	19/32"					331	55		
60466	5/8"					377			
60459	21/32"					425	65		
60467	11/16"					477	70		20
60468	3/4"					531			
60469	25/32"						80		1
60470	13/16"								15
60471	7/8"						85		
60472	15/16"						95		
60473	31/32"						125		10
60474	1"	40					135		
60475	1.1/16"	42							
60476	1.1/8"						185		8
60477	1.3/16"	44							
60478	1.1/4"						210		7

UNE 16501:2009 (ISO 1711-1) Cr-V DIN 3124

- x 50% aerospace chrome plating
- 50% mirror polished chrome plating
- y 100% mirror polished chrome plating

SOCKET WRENCHES

1/2"

Inch.

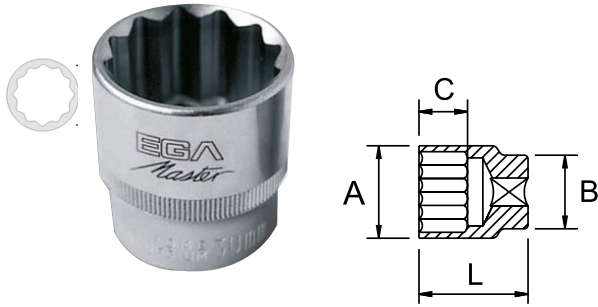

COD X	AF	L	A	B	C	MAXIMUM TORQUE Nm	gr.		
60480	5/16"		13			75	46		
60481	3/8"		15		13	147	49		
60482	7/16"		17			178	50		
60483	1/2"		19			249		25	
60484	9/16"		20	22		288			
60485	19/32"		22		14	331	55		
60486	5/8"					377			
60479	21/32"	38				425	65		
60487	11/16"		24			477	70	20	
60488	3/4"		26	23		531			1
60489	25/32"			24			80		
60490	13/16"		28				85	15	
60491	7/8"		30	25			95		
60492	15/16"		32	26	18				
60493	31/32"		33			569	125		
60494	1"	40	34	28			135	10	
60495	1.1/16"		36						
60496	1.1/8"	42	38	32	19		185		8
60497	1.3/16"		40		22				
60498	1.1/4"	44	42	34	23		210	7	

UNE 16501:2009 (ISO 1711-1) Cr-V DIN 3124

LONG SOCKETS

1/2"

mm

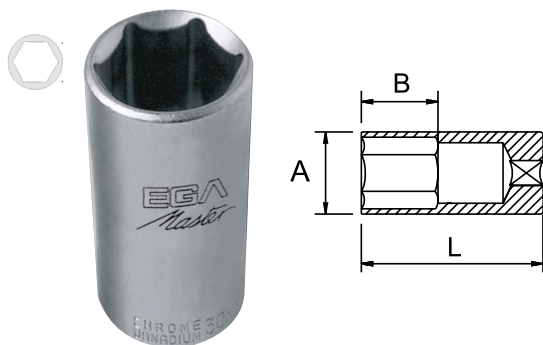

COD X	AF	L	A	B	MAXIMUM TORQUE Nm	gr.			
65044	10mm		16			147	110		
65045	11mm		17			178			
65046	12mm		18		22	212			
65047	13mm		19			249	115		
65048	14mm		21			288			
65049	15mm					331			
65050	16mm		22	26		377	125		
65051	17mm		24			425	130		
65052	18mm					477	150		
65053	19mm		26			531	165		
65054	21mm	75	28				180	10	1
65055	22mm		30				210		
65056	23mm						240		
65057	24mm		32				260		
67770	26mm			32			330		
67771	27mm		36			569	350		
67772	28mm						380		
67773	29mm		38						
67774	30mm		40				420		
67775	32mm		42				460		

UNE 16501:2009 (ISO 1711-1) Cr-V DIN 3124

- x 50% aerospace chrome plating
- x 50% mirror polished chrome plating
- y 100% mirror polished chrome plating

LONG SOCKETS

1/2"
mm

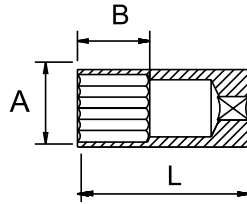

COD X	mm	L	A	B	MAXIMUM TORQUE Nm	gr.		
67780	10mm		16		147	110		
67781	11mm		17		178			
67782	12mm		18		212			
67783	13mm		19	22	249	115		
67784	14mm		21		288			
67785	15mm		22		331	125		
67786	16mm		22	26	377			
67787	17mm		24		425	130		
67788	18mm		26		477	150		
67789	19mm	75	26		531	165	10	1
67791	21mm		28			180		
67792	22mm		30			210		
67793	23mm		30			240		
67794	24mm		32	32		260		
67795	26mm		36		569	330		
67796	27mm		36			350		
67797	28mm		38			380		
67798	29mm		40			420		
67799	30mm		40			420		
67800	32mm		42			460		

UNE 16501:2009 (ISO 1711-1) Cr-V DIN 3124

1/2"
Inch.

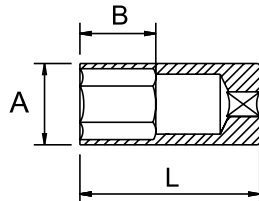

COD y	Inch.	L	A	B	MAXIMUM TORQUE Nm	gr.		
65064	3/8"		15	24	147	105		
65065	7/16"		17		178	115		
65066	1/2"		19	27	249			
65067	9/16"		21		288	120		
65068	5/8"	75	22		377		10	1
65069	11/16"		24		477	125		
65070	3/4"		26	34	531	150		
65071	13/16"		27			170		
65072	7/8"		30		569	210		
65073	15/16"		32			250		

UNE 16501:2009 (ISO 1711-1) Cr-V DIN 3124

1/2"
Inch.

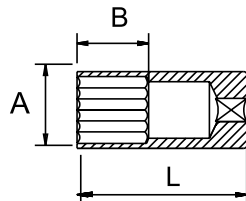

COD y	Inch.	L	A	B	MAXIMUM TORQUE Nm	gr.		
67805	3/8"		15	24	147	105		
67806	7/16"		17		178	115		
67807	1/2"		19	27	249			
67808	9/16"		21		288	120		
67809	5/8"	75	22		377		10	1
67810	11/16"		24		477	125		
67811	3/4"		26		531	150		
67812	13/16"		27			170		
67813	7/8"		30	34		210		
67814	15/16"		32			250		
67815	1"		34		569	280		
67816	1.1/16"		36			330		
67817	1.1/8"		38			370		
67818	1.1/4"					455		

UNE 16501:2009 (ISO 1711-1) Cr-V DIN 3124

- x 50% aerospaceal chrome plating
- x 50% mirror polished chrome plating
- y 100% mirror polished chrome plating

TORX®*

1/2"

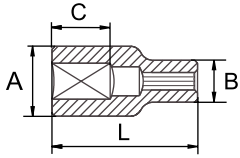

COD	TX	L	A	B	C	gr.	gr.	gr.
57179	E10		15		10	55		
57180	E11		17		11	57		
57181	E12		18			62		
57182	E14		20	22	13	67		
57183	E16	38	21			73	10	1
57184	E18		24			80		
57185	E20		26	23	14			
57186	E22		28	25		102		
57187	E24							

SPLINE

1/2"

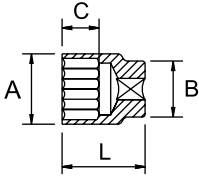
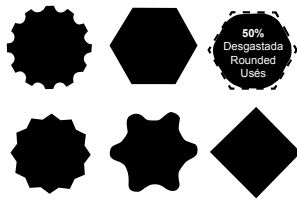

COD y	AF	AF	TX	L	A	B	C	MAXIMUM TORQUE Nm	gr.	gr.	gr.
55795	-	-		10mm	-			15,5	147	47	
55811	-	3/8"						17	178	48	
55796	M14	7/16"	11mm	E14				18	212		25
55797	M15	-	12mm	E16				19	249		
55798	M16	1/2"	13mm	-		22	14	21	288	50	
55799	M18	-	14mm	E18				21	331		
55800	-	-	15mm	-				24	377	65	
55801	M20	5/8"	16mm	E20	38			26	425	60	20
55802	-	-	17mm	-				23	477	75	1
55803	M22	-	18mm	E22				26	531	60	
55804	M24	3/4"	19mm	E24				28	80		15
55805	M25	-	20mm	-				24	70		
55806	M26	13/16"	21mm	-			17	30	85		
55807	M28	7/8"	22mm	-				26	95		
55808	M30	15/16"	24mm	-				32	115	10	
55833	-	1"	-	-	40	34	28	19	569	180	
55809	M34	1.1/16"	27mm	-	42	36	32	20	140		
55834	-	1.1/8"	-	-	43	38	32	20	155	8	
55810	M38	1.3/16"	30mm	-	44	40	35	22	180		

UNE 16501:2009 (ISO 1711-1) Cr-V DIN 3120

SCREW EXTRACTOR FOR 50% ROUNDED OFF NUTS

1/2"

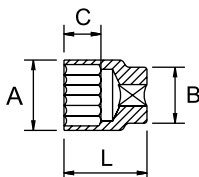

COD y	AF	L	A	B	C	MAXIMUM TORQUE Nm	gr.	gr.	gr.
55795	10mm		15,5			147	47		
55796	11mm		17			178	48		
55797	12mm		18			212			
55798	13mm		19	22	14	249	50	25	
55799	14mm		21			288			
55800	15mm					331			
55801	16mm	38	24			377	65		
55802	17mm					425	60	20	1
55803	18mm		26	23		477	75		
55804	19mm					531	60		
55805	20mm		28	24			80		15
55806	21mm				17		70		
55807	22mm		30	26			85		
55808	24mm		32	28		569	95	10	
55809	27mm	42	36	32	20		140		8
55810	30mm	44	40	35	22		180		

UNE 16501:2009 (ISO 1711-1) Cr-V DIN 3120

* For screws TORX® (Acument Intellectual Properties, LLC, Troy, Mich., US registered trademark)

ADAPTER



COD	1/2"	gr.		
65885	1/2-3/8"	50	6	1
65882	1/2-3/4"	125	6	1

SPARK PLUG SOCKETS

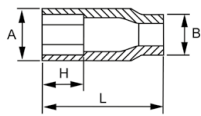

COD	1/2"	gr.						
61462	16mm	22	22	14	65	100	6	1
61463	21mm	28	24	16	65	150	6	1

SWIVEL HANDLE



COD	1/2"	gr.		
61441	0 - 180°	390 mm	650	

QUICK RELEASE SWIVEL HANDLE



COD	1/2"	gr.		
61483	470 mm	900	5	

TELESCOPIC SWIVEL HANDLE

Made of CR-V steel

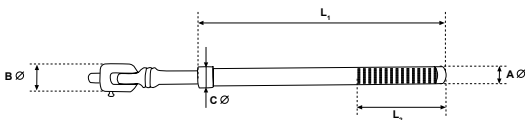

COD	1/2"	gr.								
61484	180°	430	650	305	110	21,5	33	25	1150	5

EXTENSION

Made of CR-V steel

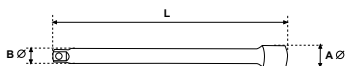

COD	1/2"	gr.					
61453	3"	75 mm				135	1
61455	5"	125 mm				220	1
61458	10"	250 mm	22 mm	15,5mm		370	5
61464	15"	375 mm				740	-
61472	20"	500 mm				590	-

DIN 3123

SPEEDER HANDLE

Made of CR-V steel

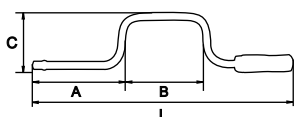

COD	1/2"	gr.					
61434	410 mm	130 mm	145 mm	95	550	5	

DIN 3122

REVERSIBLE RATCHET HANDLE

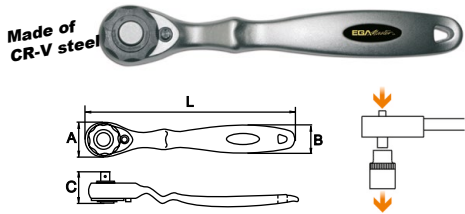

COD									
61430	1/2"	5°	230	39	31	45	550	6	1
Gearless								DIN 3122	

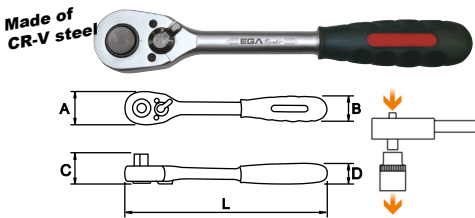

COD										
61431	1/2"	9°	250	37	32	37	28	550	6	1
40 Teeth								DIN 3122		

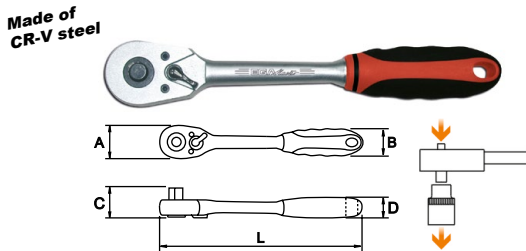

COD										
62606	1/2"	7,5°	250	42	36	37	28	560	6	1
48 Teeth								DIN 3122		

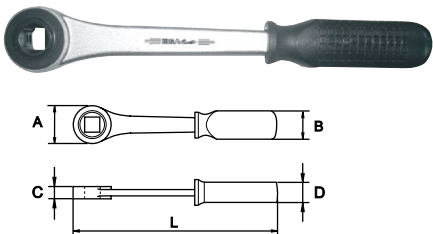

COD									
61168	1/2"	280	45	40	25	25	540	6	1

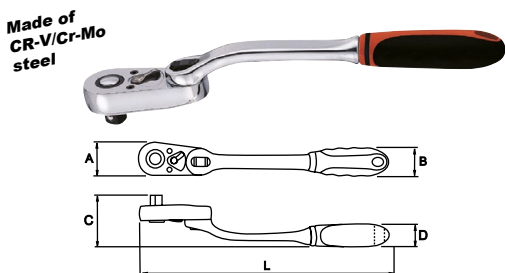

COD									
57410	1/2"	310	40	36	72	28	750	6	1
48 Teeth								DIN 3122	

REVERSIBLE RATCHET HANDLE

Made of
 CR-V/Cr-Mo
 steel

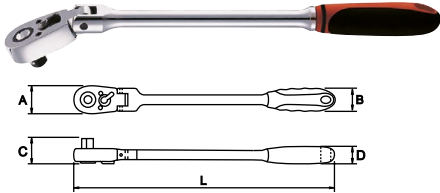

COD

57413	12"	450	37	36	38	28	880	6	1
-------	-----	-----	----	----	----	----	-----	---	---

48 Dientes

DIN 3122

Made of
 CR-V/Cr-Mo
 steel

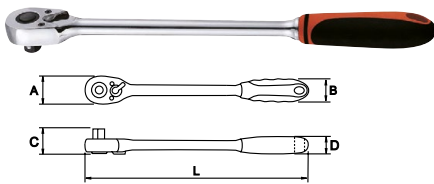

COD

57416	1/2"	380	42	36	38	28	710	6	1
-------	------	-----	----	----	----	----	-----	---	---

48 Dientes

DIN 3122

SLIDING "T" HANDLE

Made of
 CR-V steel

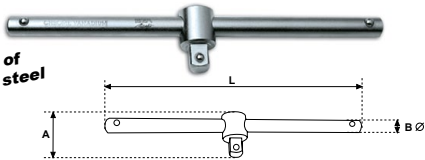

COD

61440	1/2"	250 mm	42 mm	13 mm	160	5	1
-------	------	--------	-------	-------	-----	---	---

Capable of providing a minimum 282 Nm torque.

DIN 3122

UNIVERSAL JOINT

Made of
 CR-V steel

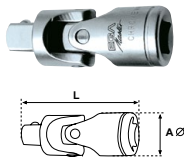

COD

61437	1/2"	71,5 mm	25 mm	140	10	1
-------	------	---------	-------	-----	----	---

Capable of providing a minimum 284 Nm torque.

DIN 3123

TECHNICAL FEATURES







MATERIAL	Cr-V
MINIMUM HARDNESS	39 HRC

SETS

1/2"







19pcs

COD			
55668	M12, M14, M15, M16, M18, M20, M22, M24, M25, M26, M28, M30, M34, M38		3,5
	Ratchet		●
	Extension		5"-10"
	T Handle		●
	Universal Joint		●







20pcs

COD			
55599	8-9-10-11-12-13-14-15-16-17-18-19-21-22-23-24mm		2,95
	Ratchet		●
	Extension		5"-10"
	Universal Joint		●



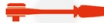





20pcs

COD			
55600	8-9-10-11-12-13-14-15-16-17-18-19-21-22-23-24mm		2,95
	Ratchet		●
	Extension		5"-10"
	Universal Joint		●









21pcs

COD			
55601	10-11-12-13-14-15-16-17-18-19-21-22-24-27-30-32mm		3,5
	Ratchet		●
	Extension		5"-10"
	T Handle		●
	Universal Joint		●

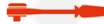

25pcs





COD			
61960	10-11-12-13-14-15-16-17-18-19-20-21-22-23-24-26-27-28-30-32mm		4,2
61963	5/16"-3/8"-7/16"-1/2"-9/16"-19/32"-5/8"-21/32"-11/16"-3/4"-25/32"-13/16"-7/8"-15/16"-31/32"-1"-1.1/16"-1.1/8"-1.3/16"-1.1/4"		
	Ratchet		●
	Extension		5"-10"
	T Handle		●
	Universal Joint		●

SETS

1/2"









25pcs

COD		Kg.
55602	10-11-12-13-14-15-16-17-18-19-20-21-22-23-24-25-26-27-28-30-32mm	3,5
	Ratchet 	●
	Extension 	5"
	T Handle 	●
	Universal Joint 	●









28pcs

COD		Kg.
55597	8-9-10-11-12-13-14-15-16-17-18-19-21-22-23-24-26-27-28-29-30-32mm	5,35
	Ratchet 	●
	Extension 	5"-10"
	T Handle 	●
	Universal Joint 	●
	Speeder handle 	●







28pcs

COD		Kg.
55598	8-9-10-11-12-13-14-15-16-17-18-19-21-22-23-24-26-27-28-29-30-32mm	5,35
	Ratchet 	●
	Extension 	5"-10"
	T Handle 	●
	Universal Joint 	●
	Speeder handle 	●



35pcs

COD		Kg.
55603	10-11-13-14-17-19-22-24-27-30-32mm 5/16"-3/8"-7/16"-1/2"-9/16"-19/32"-5/8"-21/32"-11/16"-3/4"-25/32"-13/16"-7/8"-15/16"-1"-1.1/16"-1.1/8"-1.3/16"-1.1/4"	5,7
	Ratchet 	●
	Extension 	5"-10"
	Universal Joint 	●
	Speeder handle 	●

SETS

1/2"









17pcs

COD	AF	Kg.
61796	10-11-12-13-14-15-16-17-18-19-20-22-24-27-30-32mm	2,0
61798	5/16"-3/8"-7/16"-1/2"-9/16"-5/8"-11/16"-3/4"-13/16"-7/8"-15/16"-1"-1.1/16"-1.1/8"-1.3/16"-1.1/4"	
61797	10-11-12-13-14-15-16-17-18-19-20-22-24-27-30-32mm	2,0
61799	5/16"-3/8"-7/16"-1/2"-9/16"-5/8"-11/16"-3/4"-13/16"-7/8"-15/16"-1"-1.1/16"-1.1/8"-1.3/16"-1.1/4"	
Ratchet		 ●





41pcs



COD	AF	Kg.
61793	10-11-12-13-14-15-16-17-18-19-20-21-22-23-24-27-30-32mm 3/8"-7/16"-1/2"-9/16"-5/8"-11/16"-3/4"-13/16"-7/8"-15/16"-1"-1.1/16" 1.1/8"-1.3/16"-1.1/4"	5,5
Ratchet		 ●
Extension		 6"-8"
T Handle		 ●
Universal Joint		 ●
Swivel handle		 ●
Spark plug sockets		 16-21mm

33pcs



COD	AF	Long sockets	Kg.
65074	10-11-12-13-14-15-16-17-18-19-20-21-22-23-24mm	10-11-12-13-14-15-16-17-18-19mm	7,0
65075	3/8"-7/16"-1/2"-9/16"-5/8"-11/16" 3/4"-13/16"-7/8"-15/16"-1" 1.1/16"- 1.1/8"-1.3/16"-1.1/4"	3/8"-7/16"-1/2"-9/16"-5/8"-11/16"- 3/4"-3/16"-7/8"-15/16"	
Ratchet		 ●	
Extension		 3"-5"-10"	
Swivel handle		 ●	
Universal Joint		 ●	
Spark plug sockets		 16-21mm(65074) 5/8"-13/16"(65075)	

DISPLAYS

1/2"



233pcs

UN.	COD:65296
	8mm
	9mm
	10mm
12	11mm
	12mm
	13mm
	14mm
	15mm
11	16mm
	17mm
10	18mm
	19mm
9	20mm
	21mm
	22mm
8	23mm
	24mm
	25mm
	26mm
7	27mm
	28mm
	29mm
	30mm
6	32mm



UN.	COD:65297
	8mm
	9mm
	10mm
12	11mm
	12mm
	13mm
	14mm
	15mm
11	16mm
	17mm
10	18mm
	19mm
9	20mm
	21mm
	22mm
8	23mm
	24mm
	25mm
	26mm
7	27mm
	28mm
	29mm
	30mm
6	32mm



236pcs

UN.	COD:65298
24	5/16"
	3/8"
12	7/16"
	1/22
24	9/16"
22	5/8"
20	11/16"
19	3/4"
9	13/16"
16	7/8"
8	15/16"
14	1"
7	1.1/16"
	1.1/8"
	1.3/16"
6	1.1/4"



UN.	COD:65299
24	5/16"
	3/8"
	7/16"
12	1/22
	9/16"
	19/32"
11	5/8"
	21/32"
20	11/16"
10	3/4"
9	25/32"
	13/16"
16	7/8"
8	15/16"
	31/32"
7	1"
	1.1/16"
	1.1/8"
	1.3/16"
6	1.1/4"

