

1/4" SOCKET WRENCHES



both in mm and inches

- 6 or 12 edges.



EGA Master offers a wide range of socket wrenches, both shallow and deep range series, together with a large number of additional and complementary items, such as adapters, hinged handles, extensions, ratchet wrenches, etc.

1/4", 3/8", 1/2", 3/4" and 1" square drive hand-operated sockets and 3/8", 1/2", 3/4", 1", 1.1/2", 2.1/2" and 3.1/2" square drive impact sockets wrenches, being the only in the sector offering such a wide range.

The sockets are made of **chrome-vanadium steel**, designed to withstand high tightening torques with minimal wear, providing the same greater durability.

1/4"

SOCKET WRENCHES

mm



COD X	AF	L	A	B	C	MAXIMUM TORQUE Nm	gr.	gr.	gr.
61322	3,2mm	6			7	7,08			
61311	4mm	7			8	10,4			
63974	4,5mm	8			12	12	9	30	
61312	5mm	8			15,1				
63975	5,5mm	9	12		17,8				
61313	6mm	9			20,6	10			
61314	7mm	11	25		26,8				1
61315	8mm	12			33,6	12	25		
61316	9mm	13			41,1	13			
61317	10mm	15	13		49,1	15			
61318	11mm	16	14		57,8	17	20		
61319	12mm	17		13	67	20			
61320	13mm	18	15		68,6	23			
61321	14mm	17							

UNE 16501:2009 (ISO 1711-1) Cr-V DIN 3124

mm



COD X	AF	L	A	B	C	MAXIMUM TORQUE Nm	gr.	gr.	gr.
63977	5mm	8			15,1		9	30	
63978	5,5mm	9			17,8				
63979	6mm	11	12		20,6	10			
63980	7mm	11			26,8				1
63981	8mm	12			33,6	12	25		
63982	9mm	13	25		41,1	13			
63983	10mm	15	13		49,1	15			
63984	11mm	16	14		57,8	17	20		
63985	12mm	17		13	67	20			
63986	13mm	18	15		68,6	23			
63987	14mm	17							

UNE 16501:2009 (ISO 1711-1) Cr-V DIN 3124

- x 50% aerospace chrome plating
- y 50% mirror polished chrome plating
- y 100% mirror polished chrome plating

LIFETIME GUARANTEE*

1/4"

SOCKET WRENCHES

Inch.

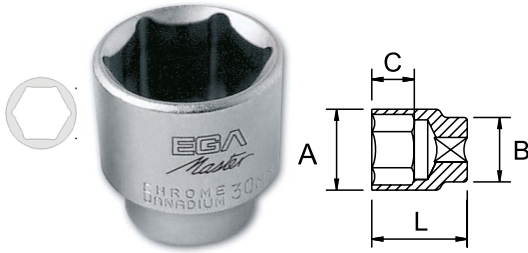

COD y		AF			MAXIMUM TORQUE Nm			gr.		
		L	A	B	C					
60420	5/32"					7	9	10,4	9	30
60421	3/16"					9		15,1		
60422	7/32"					9,5	12	17,8	10	
60423	1/4"					11		20,6	12	
60424	9/32"					11		26,8		25
60425	5/16"					12		33,6	13	
60426	11/32"					14	14	41,1	15	
60427	3/8"					14		49,1	16	
60428	7/16"					16	16	57,8	21	20
60429	1/2"					18	18	68,6	27	
60430	9/16"					20	20	13	34	

UNE 16501:2009 (ISO 1711-1) Cr-V DIN 3124

Inch.

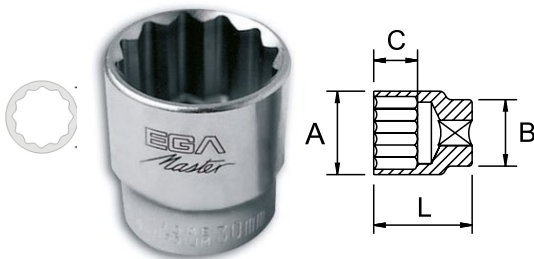

COD y		AF			MAXIMUM TORQUE Nm			gr.		
		L	A	B	C					
63989	3/16"					7	9	15,1	9	30
63990	7/32"					9		17,8	10	
63991	1/4"					9,5	12	20,6	12	
63992	9/32"					11		26,8		25
63993	5/16"					12		33,6	13	
63994	11/32"					14	14	41,1	15	
63995	3/8"					14		49,1	16	
63996	7/16"					16	16	57,8	21	20
63997	1/2"					18	18	68,6	27	
63998	9/16"					20	20	13	34	

UNE 16501:2009 (ISO 1711-1) Cr-V DIN 3124

LONG SOCKETS

mm

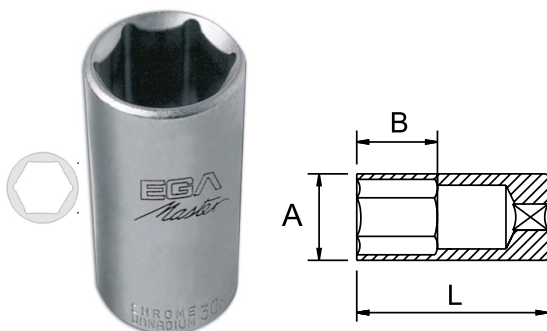

COD X		AF		MAXIMUM TORQUE Nm		gr.	
		L	A	B			
67640	4mm			7	10	10,4	20
67641	4,5mm			8		12	21
67642	5mm			9	11	15,1	23
67643	5,5mm			9		17,8	24
67644	6mm			9,5	14	20,6	26
67645	7mm			11		26,8	
67646	8mm			12	19	33,6	27
67647	9mm			13		41,1	37
67648	10mm			15	20	49,1	39
67649	11mm			16	22	57,8	46
67650	12mm			17		67	50
67651	13mm			18	23	68,6	55
67652	14mm			20		75	

UNE 16501:2009 (ISO 1711-1) Cr-V DIN 3124

- x 50% aerospaceal chrome plating
- 50% mirror polished chrome plating
- y 100% mirror polished chrome plating

LIFETIME GUARANTEE*

1/4"

LONG SOCKETS

mm

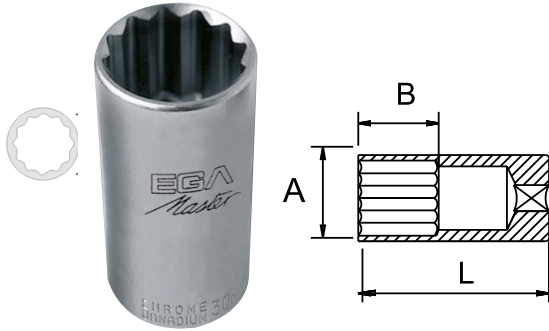

COD X	AF	L	A	B	MAXIMUM TORQUE Nm	gr.	
67660	5mm		8		15,1	23	
67661	5,5mm		9	11	17,8	24	
67662	6mm		9,5	14	20,6	26	
67663	7mm		11	19	26,8	27	
67664	8mm		12		33,6		
67665	9mm	50	13	20	41,1	37	10
67666	10mm		15		49,1	39	
67667	11mm		16	22	57,8	46	
67668	12mm		17		67	50	
67669	13mm		18	23	68,6	55	
67670	14mm		20			75	

UNE 16501:2009 (ISO 1711-1) Cr-V DIN 3124

Inch.

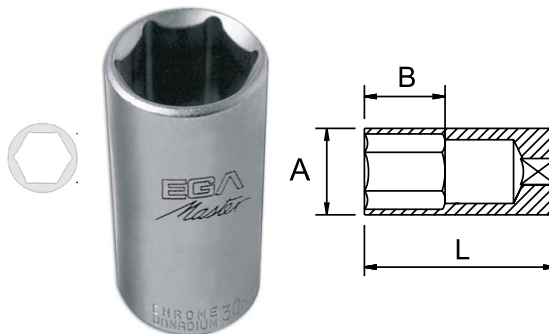

COD y	AF	L	A	B	MAXIMUM TORQUE Nm	gr.	
67674	5/32"		7	8	10,4	22	
67675	3/16"		8	11	15,1	24	
67676	7/32"		9	14	17,8		
67677	1/4"		9,5		20,6		
67678	9/32"		11	18	26,8	28	
67679	5/16"	50	12	20	33,6	30	10
67680	11/32"		13		41,1	30	
67681	3/8"			22	49,1	44	
67682	7/16"		16		57,8	45	
67683	1/2"			22	68,6	55	
67684	9/16"		20	26		70	

UNE 16501:2009 (ISO 1711-1) Cr-V DIN 3124

Inch.

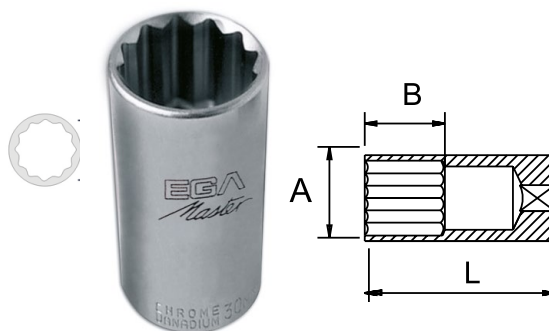

COD y	AF	L	A	B	MAXIMUM TORQUE Nm	gr.	
67689	5/32"		7	8	10,4	22	
67690	3/16"		8	11	15,1	24	
67691	7/32"		9	14	17,8		
67692	1/4"		9,5		20,6		
67693	9/32"		11	18	26,8	28	
67694	5/16"	50	12	20	33,6	30	10
67695	11/32"		13		41,1	30	
67696	3/8"			22	49,1	44	
67697	7/16"		16		57,8	45	
67698	1/2"			22	68,6	55	
67699	9/16"		20	26		70	

UNE 16501:2009 (ISO 1711-1) Cr-V DIN 3124

- x 50% aerospace chrome plating
- 50% mirror polished chrome plating
- y 100% mirror polished chrome plating

1/4"

TORX®*

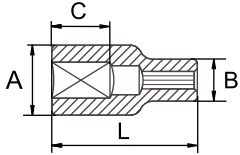

COD	Star	L	A	B	C	gr.	Red	Blue
57165	E4		7		6	11		
57166	E5		8					
57167	E6	25	9	12	8	12	25	1
57168	E7		10			13		
57169	E8		11		9	14		
57170	E10		13			16		

SPLINE

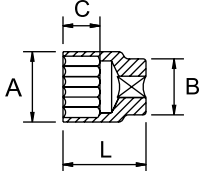
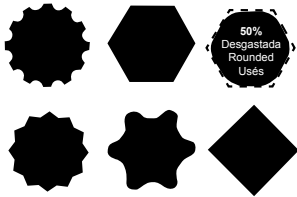

COD y	Star	AF	AF	Star	L	A	B	C	MAXIMUM TORQUE Nm	gr.	Red	Blue
56015	M5	5/32"	4mm	E5				7	10,4			
56017	M6	-	5mm	E6				8	15,1			
56018	M7	7/32"	5,5mm	-				8,5	17,8	10		30
56019	-	-	6mm	-				9	20,6			
55813	-	1/4"	-	-								
56020	M9	9/32"	7mm	-				10,5	26,8			25
56021	M10	5/16"	8mm	E10	25	13	13	10	33,6	14		1
56023	-	-	10mm	-					49,1	23		20
55814	-	3/8"	-	-				16	16	23		25
56024	M14	7/16	11mm	E14					57,8			
56025	M15	-	12mm	E16				18	18	67	27	20
56026	M16	1/2"	13mm	-				19	19		30	
56027	M18	-	14mm	E18				20	20	68,6	33	

UNE 16501:2009 (ISO 1711-1) Cr-V DIN 3120

SCREW EXTRACTOR FOR 50% ROUNDED OFF NUTS

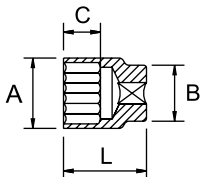

COD y	Star	L	A	B	C	MAXIMUM TORQUE Nm	gr.	Red	Blue
56015	4mm				7	10,4			
56017	5mm				8	15,1			
56018	5,5mm		12		8,5	17,8	10		30
56019	6mm				9	20,6			
56020	7mm				10,5	26,8			25
56021	8mm	25	13	13	10	33,6	14		1
56023	10mm					49,1	23		
56024	11mm					57,8			
56025	12mm				18	18	67	27	20
56026	13mm				19	19		30	
56027	14mm				20	20	68,6	33	

UNE 16501:2009 (ISO 1711-1) Cr-V DIN 3120

*For screws TORX® (Acument Intellectual Properties, LLC, Troy, Mich., US registered trademark)

1/4"

UNIVERSAL SOCKET MM



COD X	AF	L	gr.		
57279	6mm	34	23	10	1
57280	7mm				
57281	8mm				
57282	9mm				
57283	10mm	37	56	10	1
57284	11mm				
57285	12mm				
57286	13mm				
57287	14mm				

UNIVERSAL SOCKET INCH



COD y	AF	L	gr.		
57288	1/4"	34	23	10	1
57289	5/16"				
57290	3/8"				
57291	7/16"	37	56	10	1
57292	1/2"				

ADAPTER

Made of
 CR-V steel



COD	1/4"	gr.		
65880	1/4-3/8"	15	6	1

1/4" SOCKET HOLDER



COD		L	gr.		
66732	1/4"	190	95	6	1

MAGNETIC BITHOLDER SCREWDRIVER



COD		L	gr.		
66731	1/4"	215	105	6	1

MAGNETIC BITHOLDER SCREWDRIVER

1.000V
 IEC 60900



COD					
76737	1/4"	210	120	6	1

HEXAGONAL BIT



COD				PCS
55941	1/4"	50	5	

REVERSIBLE RATCHET HANDLE

Made of
 CR-V steel



COD									
61428	1/4"	150	28	21	21	15	105	6	1

40 Teeth

DIN 3122

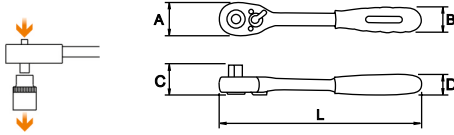

Made of
 CR-V steel



COD									
62603	1/4"	140	23	21	22	17	105	6	1

48 Teeth

DIN 3122

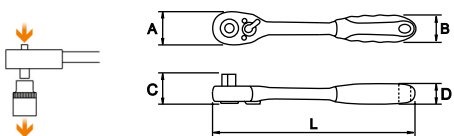

Made of
 CR-V/ CR-Mo
 steel



COD									
57411	1/4"	160	22	21	23	17	120	6	1

48 Teeth

DIN 3122

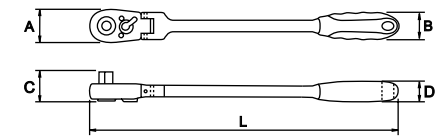

1/4"

REVERSIBLE RATCHET HANDLE

Made of
 CR-V/ CR-Mo
 steel

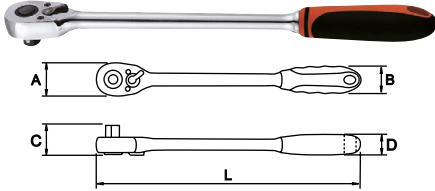

COD	1/4"	L mm	A	B	C	D	gr.	5	1
57414	1/4"	180	23	21	21	17	150	6	1

48 Teeth DIN 3122

SLIDING "T" HANDLE

Made of
 CR-V steel



COD	1/4"	L	gr.	5	1
61438	1/4"	115	60	5	1

DIN 3122

UNIVERSAL JOINT

Made of
 CR-V steel



COD	1/4"	L	gr.	10	1
61435	1/4"	30	30	10	1

DIN 3123

EXTENSION

Made of
 CR-V steel



COD	1/4"	L	gr.	5	1
61442	1/4"	2"	25	5	1
61454		3"	35		
61443		4"	45		
61444		6"	65		
62731		10"	110		

DIN 3123

SPEEDER HANDLE

Made of
 CR-V steel

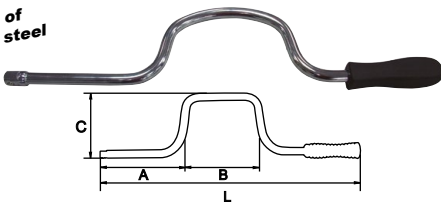

COD	1/4"	L mm	A	B	C	gr.	5
61408	1/4"	425	130	145	100	450	5

DIN 3122

FLEXIBLE HANDLE

Made of
 CR-V steel



COD	1/4"	L	gr.	5	-
61445	1/4"	6"	60	5	-

DIN 3122

SWIVEL HANDLE

Made of
 CR-V steel



COD	1/4"	L	gr.	5	1
65874	1/4"	150	260	5	1

TECHNICAL SPECIFICATIONS

MATERIAL	Cr-V
MINIMUM HARDNESS	39 HRC





LIFETIME GUARANTEE*

SETS



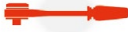





1/4"

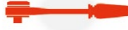

18pcs







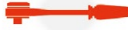

COD		Kg.
55591	4-4,5-5-5,5-6-7-8-9-10-11-12-13-14mm	0,6
	Ratchet 	●
	Extension 	4"
	T Handle 	●
	Universal Joint 	●
	Socket holder 	●

29pcs

COD		Kg.
61958	4-5-6-7-8-9-10-11-12-13-14mm	0,8
61961	5/32"-3/16"-7/32"-1/4"-9/32" 5/16"-11/32"-3/8"-7/16"-1/2"-9/16"	
	Ratchet 	●
	Extension 	2"-6"
	T Handle 	●
	Universal Joint 	●
	Hex bit socket 	3-4-5-6-8
	Flat bit socket 	4x0,6 - 5,5x1 - 7x1,2
	Philips bit socket 	PH1-PH2-PH3-PH4
	Socket holder 	●



29pcs

COD		Kg.
55667	M5, M6, M7, M8, M9, M10, M12, M14, M15, M16, M18	0,8
	Ratchet 	●
	Extension 	2"-6"
	T Handle 	●
	Universal Joint 	●
	Hex bit socket 	3-4-5-6-8
	Flat bit socket 	4x0,6 - 5,5x1 - 7x1,2
	Philips bit socket 	PH1-PH2-PH3-PH4
	Socket holder 	●



SETS

1/4"



30pcs

COD	AF	Kg.
55592	3,2-4-4,5-5-5,5-6-7-8-9-10-11-12mm	1,5
	5/32"-3/16"-7/32"-1/4"-9/32"-5/16"-11/32"-3/8"-7/16"-1/2"-9/16"	
Ratchet		●
Extension		2" - 6"
Extension		●
Swivel handle		●
T Handle		●
Universal Joint		●
Socket holder		●

33pcs

COD	Long sockets	Kg.
55590	3,2-4-5-5,5-6-7-8-9-10-11-12-13-14mm	1,5
	4-5-5,5-6-7-8-9-10-11-12-13-14mm	
Ratchet		●
Extension		2" - 6"
Extension		●
Swivel handle		●
T Handle		●
Universal Joint		●
Socket holder		●



24pcs

COD	AF	Kg.
61791	4-5-6-7-8-9-10-11-12-13mm	0,8
	3/16"-7/32"-1/4"-9/32"- 5/16"-11/32"-3/8"-7/16"-1/2"	
Ratchet		●
Extension		2"
Universal Joint		●
Swivel handle		●
Socket holder		●



LIFETIME GUARANTEE*

SETS

1/4"



12pcs

COD	AF ↓ C ↑	Kg.
61323	4-5-6-7-8-9-10-11-12-13-14mm	0,4
61324	5/32"-3/16"-7/32"-1/4"-9/32" 5/16"-11/32"-3/8"-7/16"-1/2"-9/16"	
Ratchet		●

LIFETIME GUARANTEE*