

ProfiMaster, one exhaust arm - Art. No.: 60 650 102

- » Robust quality
- » High capacity filter



Applications

- » Also suitable for high-alloy steel
- » Low to medium levels of smoke and dust
- » Occasional to frequent use

Benefits

- » Safe operation by rotation field control
- » Maintenance door allows easy filter change
- » Exhaust arm requires less adjustment due to flow-optimised exhaust hood design
- » Increased safety due to filter monitoring

Properties

- » Exhaust arm up to 4 m
- » Automatic Start/Stop (optional)
- » Rotating exhaust hood

Accessories

- » Automatic start/stop

Technical Data

Art. No.	60 650 102
Filter	
Filter stages	2
Filter method	Disposable filter
Filter surface	17 m ²
Type of filter	Filter cassette
Filter material	Non-woven fibre
Filter efficiency	> 99.5 %
Filter class	E12
Additional filters	Pre-filter
Basic data	
Extraction capacity	1100 m ³ /h
Dimensions (w x d x h)	797 x 828 x 977 mm
Weight	104 kg
Motor power	1.1 kW
Power supply	3 x 400 V / 50 Hz
Rated current	2.3 A
Control voltage	24 V, DC
Noise level	72 dB(A)
Additional information	
IFA-Certification	W3-Approved
Fan type	Radial fan
Quantity of extraction arms	1
Exhaust arm type	flexible exhaust arm
Diameter extraction arm	150 mm
Length of exhaust arm	4 m



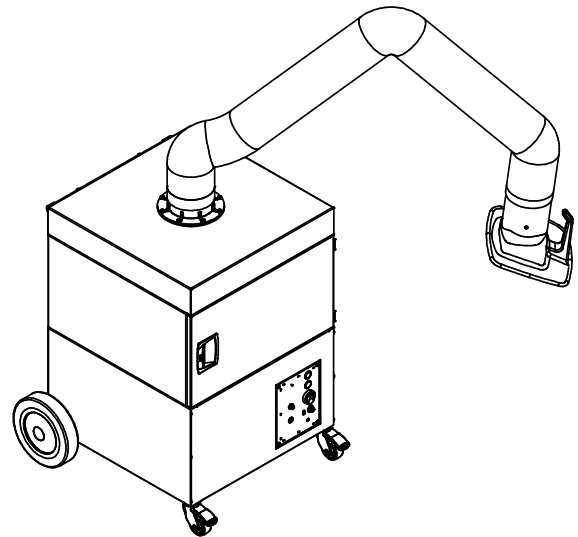
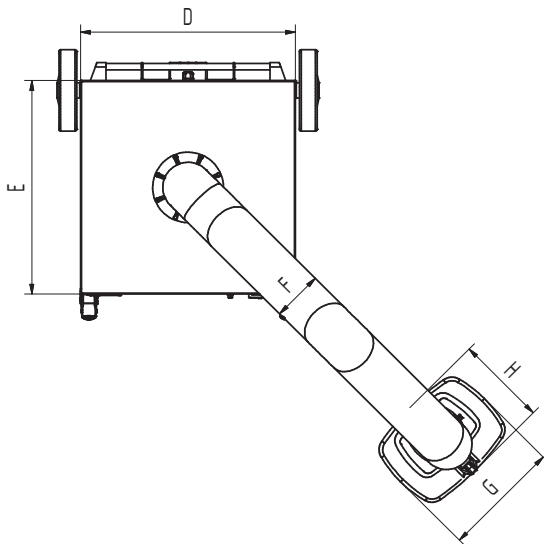
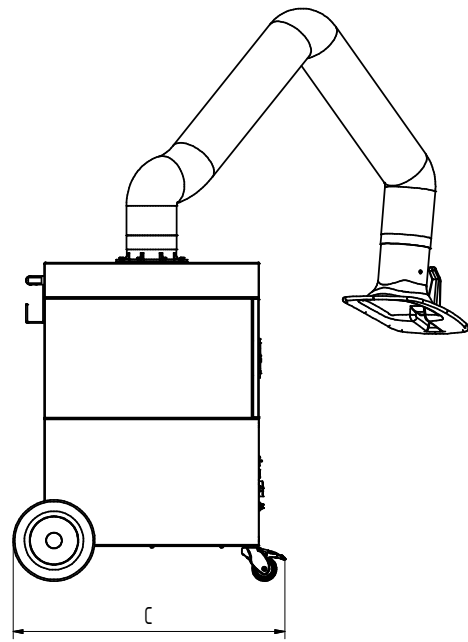
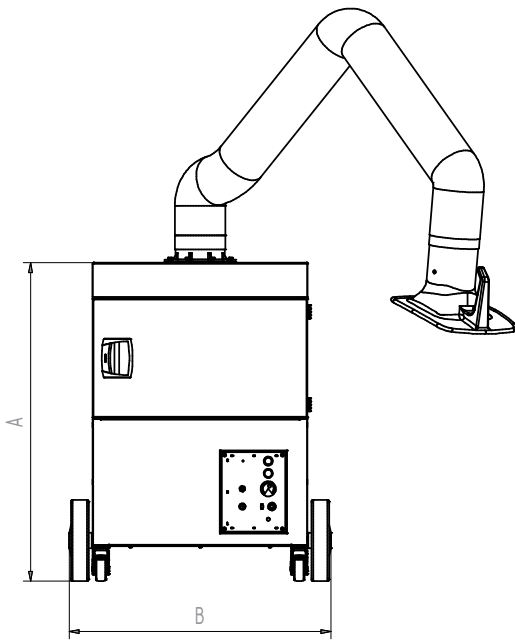

Technical Data

Dimensions	
A	977 mm
B	797 mm
C	828 mm
D	655 mm
E	655 mm
F	150 mm
G	360 mm
H	295 mm